

VIZIO



QUICK START GUIDE

Model: E600i-B3 & E700i-B3

IMPORTANT SAFETY INSTRUCTIONS

Your TV is designed and manufactured to operate within defined design limits. Misuse may result in electric shock or fire. To prevent your TV from being damaged, the following instructions should be observed for the installation, use, and maintenance of your TV. Read the following safety instructions before operating your TV. Keep these instructions in a safe place for future reference.

- To reduce the risk of electric shock or component damage, switch off the power before connecting other components to your TV.
- Read these instructions.
- Keep these instructions.
- Heed all warnings.
- Follow all instructions.
- Do not use this apparatus near water.
- Clean only with a dry cloth.
- Do not block any ventilation openings. Install in accordance with the manufacturer's instructions.
- Do not install near any heat sources such as radiators, heat registers, stoves, or other apparatus (including amplifiers) that produce heat.
- Do not defeat the safety purpose of the polarized or grounding-type plug. A polarized plug has two blades and a third grounding prong. The wide blade or the third prong are provided for your safety. If the provided plug does not fit into your outlet, consult an electrician for replacement of the obsolete outlet.
- Protect the power cord from being walked on or pinched, particularly at plugs, convenience receptacles, and the point where they exit from the apparatus.
- Only use attachments/accessories specified by the manufacturer.
- Use only with the cart, stand, tripod, bracket, or table specified by the manufacturer, or sold with the apparatus. When a cart is used, use caution when moving the cart/apparatus combination to avoid injury from tip-over.
- Unplug this apparatus during lightning storms or when unused for long periods of time.
- Refer all servicing to qualified service personnel. Servicing is required when the apparatus has been damaged in any way, such as when the power-supply cord or plug is damaged, liquid has been spilled or objects have fallen into the apparatus, the apparatus has been exposed to rain or moisture, does not operate normally or has been dropped.
- Unplug the power cord before cleaning your TV.
- When moving your TV from an area of low temperature to an area of high temperature, condensation may form in the housing. Wait before turning on your TV to avoid causing fire, electric shock, or component damage.
- A distance of at least three feet should be maintained between your TV and any heat source, such as a radiator, heater, oven, amplifier etc. Do not install your TV close to smoke. Operating your TV close to smoke or moisture may cause fire or electric shock.
- Slots and openings in the back and bottom of the cabinet are provided for ventilation. To ensure reliable operation of your TV and to protect it from overheating, be sure these openings are not blocked or covered. Do not place your TV in a bookcase or cabinet unless proper ventilation is provided.
- Never push any object into the slots and openings on your TV cabinet. Do not place any objects on the top of your TV. Doing so could short circuit parts causing a fire or electric shock. Never spill liquids on your TV.
- Your TV should be operated only from the type of power source indicated on the label. If you are not sure of the type of power supplied to your home, consult your dealer or local power company.
- Do not apply pressure or throw objects at your TV. This may compromise the integrity of the display. The manufacturer's warranty does not cover user abuse or improper installations.
- The power cord must be replaced when using different voltage than the voltage specified. For more information, contact your dealer.
- When connected to a power outlet, power is always flowing into your TV. To totally disconnect power, unplug the power cord.
- The lightning flash with arrowhead symbol within an equilateral triangle is intended to alert the user to the presence of un-isolated, dangerous voltage within the inside of your TV that may be of sufficient magnitude to constitute a risk of electric shock to persons.
- Do not overload power strips and extension cords. Overloading can result in fire or electric shock.
- The wall socket should be installed near your TV and easily accessible.
- Only power of the marked voltage can be used for your TV. Any other voltage than the specified voltage



- may cause fire or electric shock.
- Do not touch the power cord during lightning. To avoid electric shock, avoid handling the power cord during electrical storms.
- Unplug your TV during a lightning storm or when it will not be used for long period of time. This will protect your TV from damage due to power surges.
- Do not attempt to repair or service your TV yourself. Opening or removing the back cover may expose you to high voltages, electric shock, and other hazards. If repair is required, contact your dealer and refer all servicing to qualified service personnel.
- **WARNING:** Keep your TV away from moisture. Do not expose your TV to rain or moisture. If water penetrates into your TV, unplug the power cord and contact your dealer. Continuous use in this case may result in fire or electric shock.
- Do not use your TV if any abnormality occurs. If any smoke or odor becomes apparent, unplug the power cord and contact your dealer immediately. Do not try to repair your TV yourself.
- Avoid using dropped or damaged appliances. If your TV is dropped and the housing is damaged, the internal components may function abnormally. Unplug the power cord immediately and contact your dealer for repair. Continued use of your TV may cause fire or electric shock.
- Do not install your TV in an area with heavy dust or high humidity. Operating your TV in environments with heavy dust or high humidity may cause fire or electric shock.
- Follow instructions for moving your TV. Ensure that the power cord and any other cables are unplugged before moving your TV.
- When unplugging your TV, hold the AC/DC power adapter, not the cord. Pulling on the power cord may damage the wires inside the cord and cause fire or electric shock. When your TV will not be used for an extended period of time, unplug the power cord.
- To reduce risk of electric shock, do not touch the connector with wet hands.
- Insert batteries in accordance with instructions. Incorrect polarities may cause the batteries to leak which can damage the remote control or injure the operator. Do not expose batteries to excessive heat such as sunshine, fire or the like.
- If any of the following occurs, contact the dealer:
 - The power cord fails or frays.
 - Liquid sprays or any object drops into your TV.
 - Your TV is exposed to rain or other moisture.
 - Your TV is dropped or damaged in any way.
 - The performance of your TV changes substantially.
- This apparatus shall not be exposed to dripping or splashing and no objects filled with liquids, such as vases, shall be placed on the apparatus.
- The mains plug or appliance coupler is used as the disconnect device, the disconnect device shall remain readily operable.
- **CAUTION** - These servicing instructions are for use by qualified service personnel only. To reduce the risk of electric shock, do not perform any servicing other than that contained in the operating instructions unless you are qualified to do so.
- The lightning flash with arrowhead symbol within an equilateral triangle is intended to alert the user to the presence of uninsulated **DANGEROUS VOLTAGE** within the product's enclosure that may be of sufficient magnitude to constitute a risk of electrical shock to persons.



This product qualifies for ENERGY STAR in the "factory default" setting and this is the setting in which power savings will be achieved. Changing the factory default picture settings or enabling other features will increase power consumption that could exceed the limits necessary to qualify for ENERGY STAR rating.

TELEVISION ANTENNA CONNECTION PROTECTION

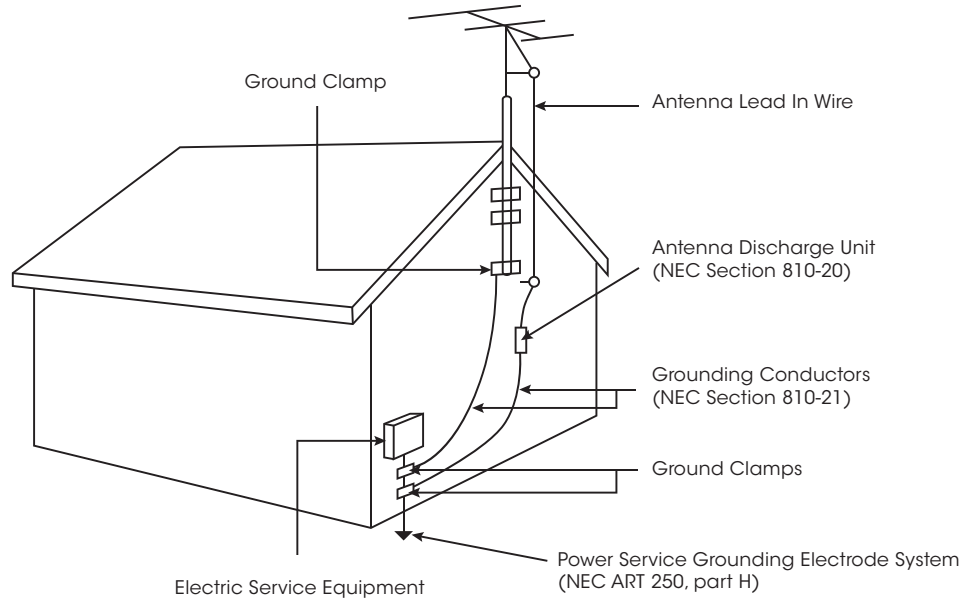

- If an outside antenna/satellite dish or cable system is to be connected to the TV, make sure that the antenna or cable system is electrically grounded to provide some protection against voltage surges and static charges.
- Article 810 of the National Electrical Code, ANSI/NFPA 70, provides information with regard to proper grounding of the mast and supporting structure, grounding of the lead-in wire to an antenna discharge unit, size of the grounding conductors, location of antenna discharge unit, connection to grounding electrodes, and requirements of the grounding electrode.
- Lightning Protection: For added protection of the TV during a lightning storm or when it is left unattended or unused for long periods of time, unplug the TV from the wall outlet and disconnect the antenna or cable system.
- Power Lines: Do not locate the antenna near overhead light or power circuits, or where it could fall into such power lines or circuits. Remember, the screen of the coaxial cable is intended to be connected to earth in the building installation.

Do You Have Questions? Find Answers At

SUPPORT.VIZIO.COM

Find help with:

- New Product Setup
- Connecting Your Devices
- Technical Problems
- Product Updates
- And More



**Live Chat
Support Available**

**Your can also contact our
award-winning support team at:**

Phone: **(877) 698-4946 (TOLL-FREE)**

Email: **techsupport@VIZIO.com**

Hours Of Operation:

Monday - Friday: **7 AM TO 11 PM (CST)**

Saturday - Sunday: **9 AM TO 6 PM (CST)**



PACKAGE CONTENTS



VIZIO LED HDTV with Stand



Remote Control with Batteries



This Quick Start Guide



Power Cord



3 x M5 16mm Phillips Screws

USING THE REMOTE

APP LAUNCHER
Quickly launch the pictured app.

INPUT
Change the currently-displayed input.

A/V CONTROLS
Control USB media player.

CLOSED CAPTIONS
Turn closed captions on and off.

EXIT
Close the on-screen menu.

BACK
Go to the previous on-screen menu.

HOT KEYS
Perform functions within an on-screen menu or app.

VOLUME UP/DOWN
Increase or decrease loudness of the audio.

MUTE
Turn the audio off or on.

NUMBER PAD
Manually enter a channel.

WIDE
Switch the display mode.

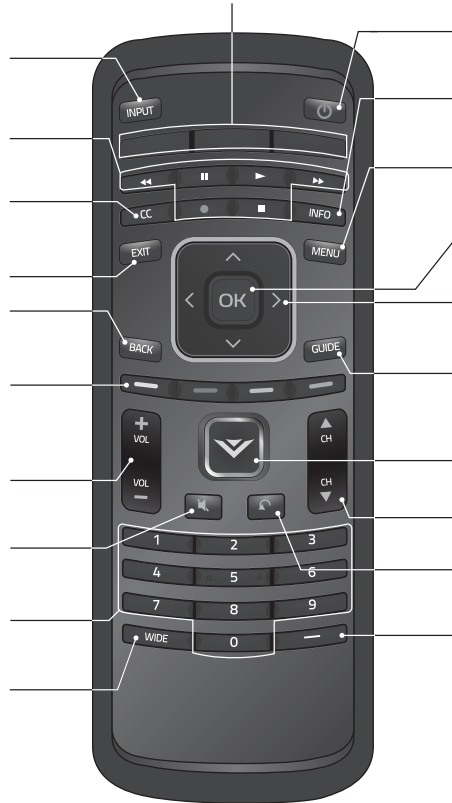

POWER
Turn TV on or off.

INFO
Display the info window.

MENU
Display the on-screen menu.

OK
Select the highlighted menu option.

ARROW
Navigate the on-screen menu.

GUIDE
Display the info window.

V BUTTON
Open the V.I.A. Plus Dock.

CHANNEL UP/DOWN
Change the channel.

LAST
Return to the channel last viewed.

DASH
Use with number pad to manually enter a digital sub-channel.
(For example, 18-4 or 18-5.)

INSTALLING THE BASE

1

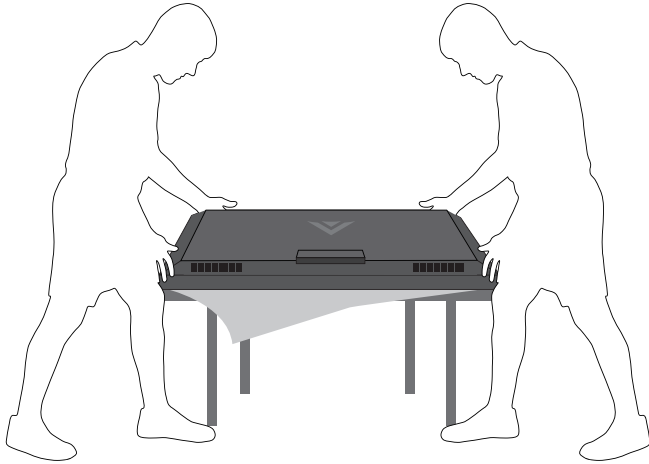

It is recommended that two people take part in the base installation.

Place the TV screen-down on a clean, flat surface. To prevent scratches or damage to the screen, place the TV on a soft surface, such as carpet, rug, or blanket.

2

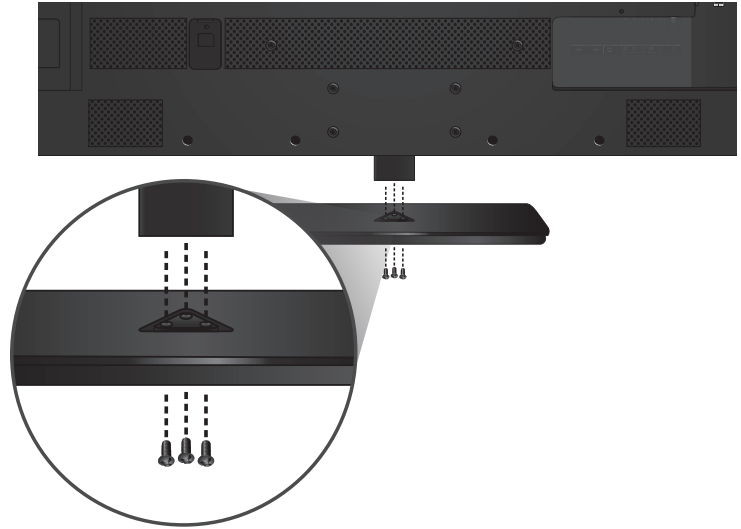

Align the base with the neck, making sure the tabs are properly inserted.

Insert three (3) M5 16mm Phillips screws (included) and tighten them using a Phillips screwdriver to secure the base to the TV.

When you are finished, place the TV on a stable, level surface.

FIRST-TIME SETUP

- 1 Connect all of your devices first.
Choose **ONE** connection type for each device.

Match colored connectors to colored ports.

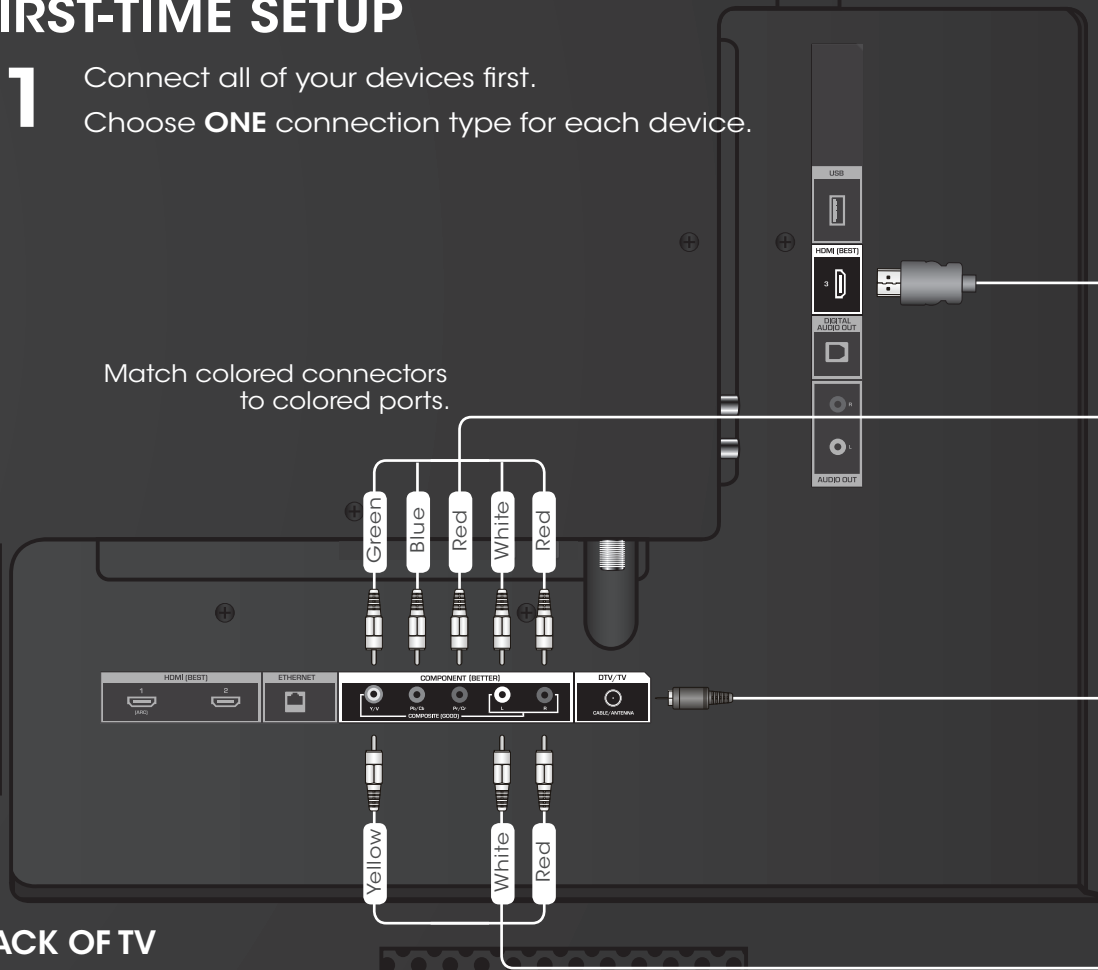

BACK OF TV

Note: The image shown here is for illustrative purposes only and may be subject to change. The actual number of ports and their locations may vary, depending on the model.

HDMI CABLE*

BEST

- DIGITAL
- HD VIDEO (1080p)†
- HD AUDIO



COMPONENT CABLE*

BETTER

- ANALOG
- HD VIDEO (1080i)†
- STEREO AUDIO

Match colored connectors to colored ports.

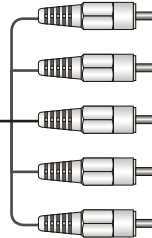

COAXIAL CABLE*

BETTER

- ANALOG
- HD VIDEO (1080i)†
- STEREO AUDIO



AV CABLE*

GOOD

- ANALOG
- VIDEO (480i)†
- STEREO AUDIO

Match colored connectors to colored ports.

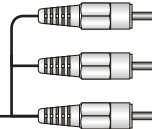

Commonly-Connected
Devices:



Cable or Satellite Boxes



Blu-ray™ or DVD Players



Game Consoles

* Cables are not included

† Maximum Resolution

2



Remove the battery cover by pressing gently on the V logo and sliding away from the remote.
Insert the included batteries.
Gently slide the battery cover back into place.

3

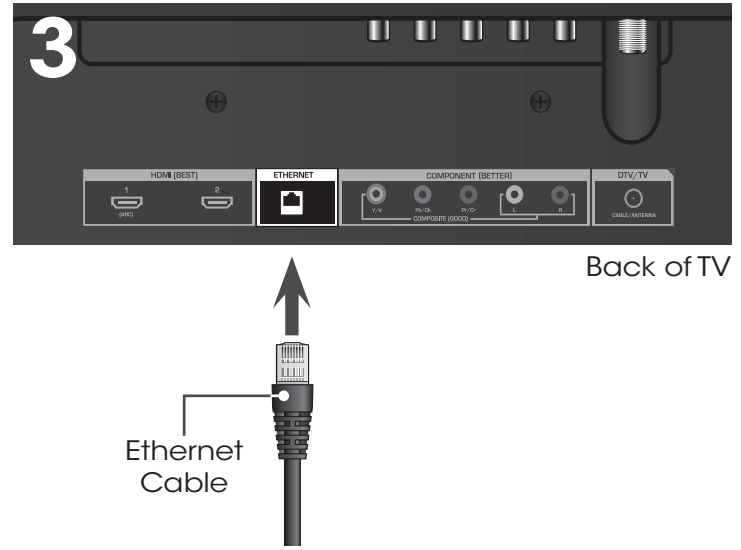

If you have a high-speed internet connection, connect an Ethernet cable from your modem or router to the back of the TV as shown.

For the best Smart TV experience, VIZIO recommends using an Ethernet cable. However, your TV also has built-in Wi-Fi. See the *Connecting to the Internet with Wi-Fi* section for more information.

Note: The image shown here is for illustrative purposes only and may be subject to change. The actual number of ports and their locations may vary, depending on the model.

4



Connect the power cord to the back of the TV. The flat edge of the connector goes toward the inside of the TV.

Plug the power cord into an electrical outlet.

Note: The image shown here is for illustrative purposes only and may be subject to change. The actual number of ports and their locations may vary, depending on the model.

5

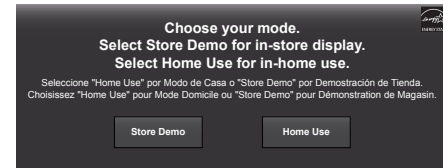

Turn the TV on by pressing the **Power** button on the remote.

The **Setup App** is displayed.

Use the Arrow buttons on the remote to highlight **Home Use** and press **OK**.

Follow the on-screen instructions to complete the first-time setup.

CONNECTING TO THE INTERNET WITH WIFI

1



If you have already set up a wireless connection during the first-time setup, you can skip this section.

To connect to a wireless network you will need:

- Wireless Router
- High-speed Internet connection
- SSID (Wireless network name)
- Network Password

For streaming video, your Internet connection speed should be 1.5 Mbps or higher.

If you don't know how fast your connection speed is, contact your Internet Service Provider (ISP).

2

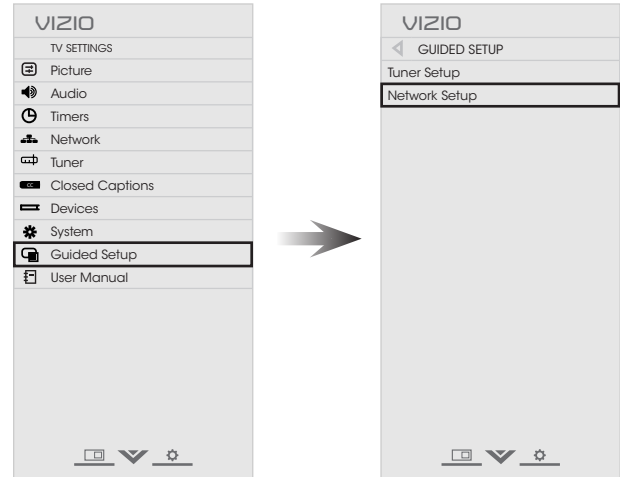

Press the **MENU Button** to display the TV SETTINGS menu. Use the **Arrow Buttons** to highlight **Guided Setup** and press **OK**. The GUIDED SETUP menu is displayed.

Highlight **Network Setup** and press **OK**. The Network Setup guide is displayed.

3

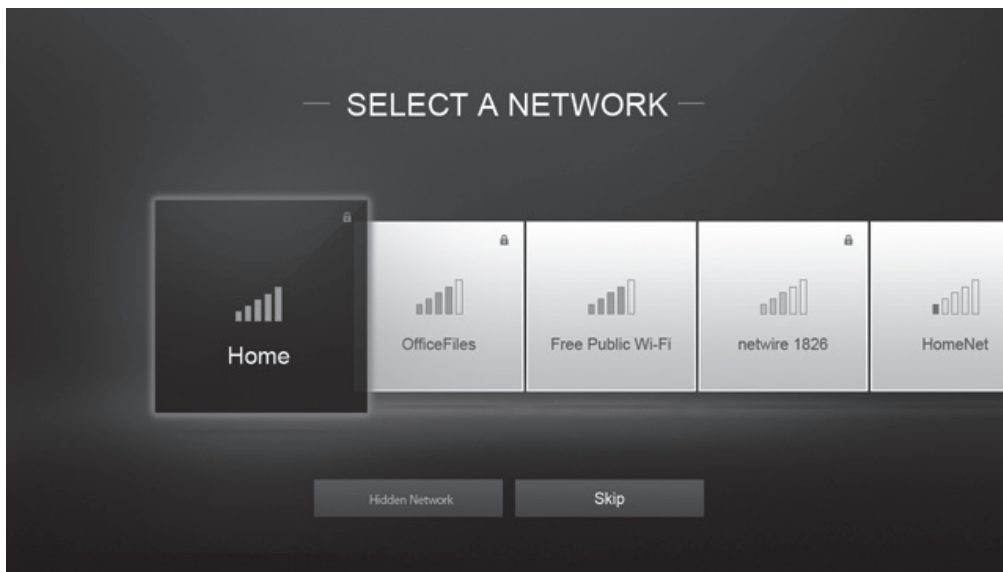

Highlight the name of your wireless network (this is the network's SSID) and press **OK**. If you do not see your SSID, you will need to enter it manually by selecting **Hidden Network**. For more information, see the TV's User Manual. Using the on-screen keyboard, enter your network's password, then highlight **Connect** and press **OK**.



If you are having trouble connecting to your network, check your router placement. It should be in a place with minimal structural interference like walls or large metal objects, and away from any other devices that are broadcasting at 2.4GHz.

VIEWING THE ON-SCREEN USER MANUAL

1



MENU
Button

Press the **MENU** button on the remote control to display the SETTINGS menu.

2

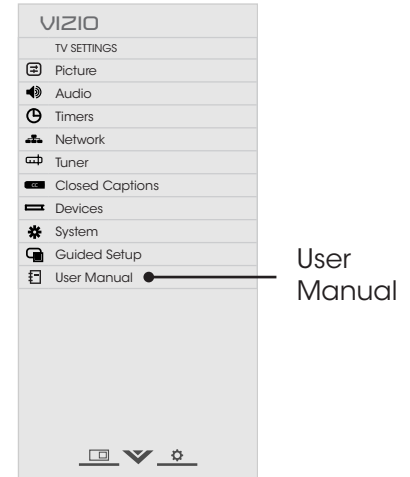

User
Manual

Highlight **User Manual** and press **OK**.

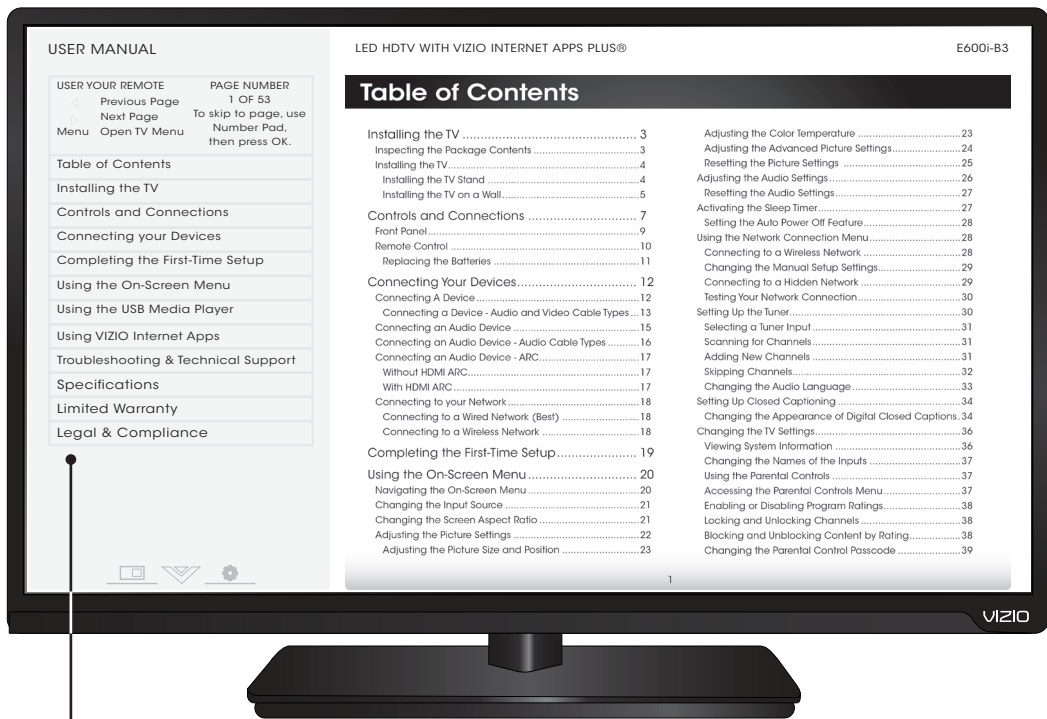

USER MANUAL

LED HDTV WITH VIZIO INTERNET APPS PLUS®

E600i-B3

USER YOUR REMOTE	PAGE NUMBER
Previous Page	1 OF 53
Next Page	To skip to page, use
Menu	Number Pad, then press OK.

Table of Contents	
Installing the TV	
Controls and Connections	
Connecting your Devices	
Completing the First-Time Setup	
Using the On-Screen Menu	
Using the USB Media Player	
Using VIZIO Internet Apps	
Troubleshooting & Technical Support	
Specifications	
Limited Warranty	
Legal & Compliance	

Table of Contents

Installing the TV	3	Adjusting the Color Temperature	23
Inspecting the Package Contents	3	Adjusting the Advanced Picture Settings	24
Installing the TV	4	Resetting the Picture Settings	25
Installing the TV Stand	4	Adjusting the Audio Settings	26
Installing the TV on a Wall	5	Resetting the Audio Settings	27
Controls and Connections	7	Activating the Sleep Timer	27
Front Panel	9	Setting the Auto Power Off Feature	28
Remote Control	10	Using the Network Connection Menu	28
Replacing the Batteries	11	Connecting to a Wireless Network	28
Connecting Your Devices	12	Changing the Manual Setup Settings	29
Connecting A Device	12	Connecting to a Hidden Network	29
Connecting a Device - Audio and Video Cable Types	13	Testing Your Network Connection	30
Connecting an Audio Device	15	Setting Up the Tuner	30
Connecting an Audio Device - Audio Cable Types	16	Selecting a Tuner Input	31
Connecting an Audio Device - ARC	17	Scanning for Channels	31
Without HDMI ARC	17	Adding New Channels	31
With HDMI ARC	17	Skipping Channels	32
Connecting to your Network	18	Changing the Audio Language	33
Connecting to a Wired Network (Best)	18	Setting Up Closed Captioning	34
Connecting to a Wireless Network	18	Changing the Appearance of Digital Closed Captions	34
Completing the First-Time Setup	19	Changing the TV Settings	36
Using the On-Screen Menu	20	Viewing System Information	36
Navigating the On-Screen Menu	20	Changing the Names of the Inputs	37
Changing the Input Source	21	Using the Parental Controls	37
Changing the Screen Aspect Ratio	21	Accessing the Parental Controls Menu	37
Adjusting the Picture Settings	22	Enabling or Disabling Program Ratings	38
Adjusting the Picture Size and Position	23	Locking and Unlocking Channels	38
		Blocking and Unblocking Content by Rating	38
		Changing the Parental Control Passcode	39



Use the **Up** and **Down** Arrow buttons to select the chapter you want to view.

Use the **Left** and **Right** Arrow buttons to browse through the pages in each chapter.

Press the **EXIT** button to exit the on-screen User Manual.

GETTING STARTED WITH VIZIO INTERNET APPS PLUS®

VIZIO Internet Apps Plus® (V.I.A. Plus) delivers popular online content to your TV. V.I.A. Plus features a selection of Apps that allow you to watch movies and TV shows, listen to music, get weather and news information, and more—all on demand.



A high-speed Internet connection is required to receive product updates and to access online content.



Press the **OK** button to launch an App.

Press the **Left/Right** Arrow buttons to scroll through the Apps on the dock. (The highlighted App is in the center of the dock.)

Press the **V Button** to display the V.I.A. Plus App Dock.
Press the **V Button** twice to launch the fullscreen V.I.A. Plus Apps window.

The fullscreen V.I.A. Plus Apps window allows you to add and store apps. The Apps on the first page are displayed in the Dock and Apps on additional pages can be moved to the Dock.

Press the **V Button** twice to launch the fullscreen V.I.A. Plus Apps window.

My Apps

Features the apps installed on your TV.

Installed Apps

The Apps displayed here are also available in the V.I.A. Plus App Dock.

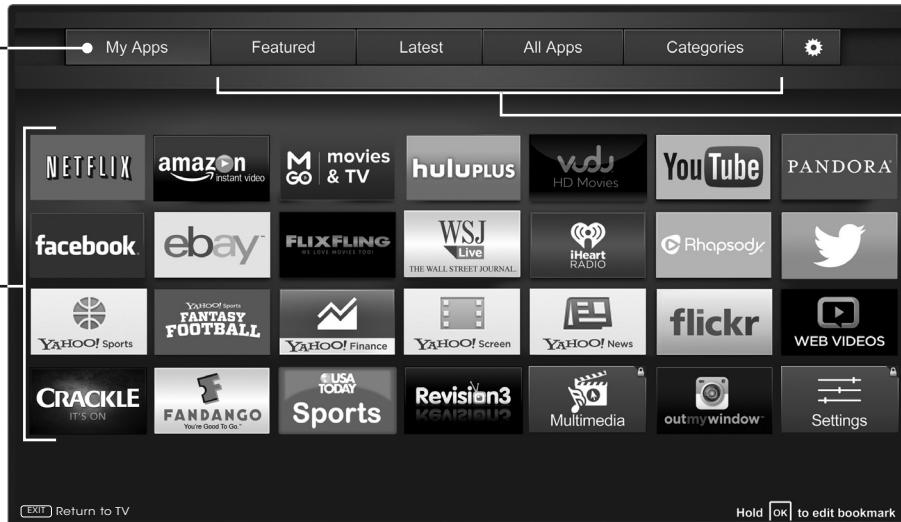

App Tabs

Browse through apps on these tabs and add them to your My Apps tab.

You can also open the app directly from the app store.

Note: App location, appearance, and availability subject to change without notice.

VIZIO RECOMMENDS



S2121w-D0 2.1 Channel Sound Stand with Integrated Subwoofer

Introducing an evolution in home theater and compact, versatile design that delivers booming audio where there isn't room for a sound bar. With outstanding audio performance and a built-in subwoofer, the VIZIO 21" 2.1 Sound Stand is the perfect and convenient audio upgrade for TVs up to 55 inch class in traditional media cabinets or any room in the house.

Available at www.VIZIO.com

This Product Sold Separately

VIZIO RECOMMENDS



BRING HOME THE MOVIE THEATER EXPERIENCE

42" 5.1 HOME THEATER SOUND BAR WITH WIRELESS SUB & SATELLITE SPEAKERS

For the pinnacle of surround sound immersion and convenience, the VIZIO S4251w 5.1 Sound Bar sets the bar exceptionally high. Designed to fit any medium to large sized HDTV, this sound bar comes with a wireless subwoofer, rear satellite speakers and is packed with the latest in Dolby and DTS audio technology. Bluetooth connectivity lets you stream your music wirelessly letting you turn any room into the ultimate home theater.

Available at www.VIZIO.com

This Product Sold Separately

HELP TOPICS

- | | |
|--|--|
| How do I return to the Setup App? | <ul style="list-style-type: none">• The on-screen menu has guided setup. Press MENU > Guided Setup. Select the type of setup you need and press OK. The Setup App begins.• To reset the TV to factory defaults, press MENU > System > Reset & Admin > Reset TV to Factory Defaults. If you have changed the default Parental Control Passcode, enter it now. Select Reset. Remember that all of your settings will be lost. |
| There is a picture, but there is no sound. | <ul style="list-style-type: none">• Press the VOLUME UP button on the remote.• Press the MUTE button on the remote to ensure that mute is off.• Press MENU, then select Audio. Be sure TV Speakers is set to On. |
| The TV displays "No Signal." | <ul style="list-style-type: none">• Be sure your connected devices are turned on.• Press the INPUT button on the remote and select the input to which your device is connected (HDMI-1, COMP, etc). |
| There are black/gray bars on the top/bottom/sides of the screen. | <ul style="list-style-type: none">• Note that some television channels add black bars to the picture.• Set the TV image mode so that the picture fills the screen. Press the WIDE button on the remote until the screen is filled, and then press OK.• Adjust the video settings of your external device. |
| There is no power. | <ul style="list-style-type: none">• Be sure the power cord is securely connected to the AC socket on the TV and to a working electrical outlet.• Press the POWER button on the remote or on the side of the TV.• If the above steps do not work, try plugging the power cord into a different outlet. |
| V.I.A. Plus is not working. | <ul style="list-style-type: none">• Be sure your TV is connected to the Internet.• Restart the App by pressing the EXIT button to close the App, then open the App.• Restart your TV by pressing the POWER button on the remote, then turn it back on. |

LEGAL / COMPLIANCE

FCC Class B Radio Interference Statement

NOTE: This equipment has been tested and found to comply with the limits for a Class B digital device, pursuant to Part 15 of the FCC Rules. These limits are designed to provide reasonable protection against harmful interference in a residential installation. This equipment generates, uses and can radiate radio frequency energy, and if not installed and used in accordance with the instructions, may cause harmful interference to radio communications. However, there is no guarantee that interference will not occur in a particular installation. If this equipment does cause harmful interference to radio or television reception, which can be determined by turning the equipment off and on, the user is encouraged to try to correct the interference by one or more of the following measures:

- Reorient or relocate the receiving antenna.
- Increase the separation between the equipment and receiver.
- Connect the equipment into an outlet on a circuit different from that to which the receiver is connected.
- Consult the dealer or an experienced radio/TV technician for help.

This device complies with Part 15 of the FCC Rules. Operation is subject to the following two conditions: (1) this device may not cause harmful interference, and (2) this device must accept any interference received, including interference that may cause undesired operation.

LIMITED WARRANTY - USA

ON PARTS AND LABOR

Covers units purchased as new in United States and Puerto Rico Only.

VIZIO provides a warranty to the original purchaser of a new Product against defects in materials and workmanship for a period of one (1) year of non-commercial usage and ninety (90) days of commercial use. If a Product covered by this warranty is determined to be defective within the warranty period, VIZIO will either repair or replace the Product at its sole option and discretion.

To obtain warranty service, contact VIZIO Technical Support via e-mail: TechSupport@VIZIO.com or via phone at 877 MY VIZIO (877.698.4946) from 7:00AM to 11:00PM Monday through Friday and 9:00AM to 6:00PM Saturday and Sunday, Central Time, or visit www.VIZIO.com. PRE-AUTHORIZATION MUST BE OBTAINED BEFORE SENDING ANY PRODUCT TO A VIZIO SERVICE CENTER. Proof of purchase in the form of a purchase receipt or copy thereof is required to show that a Product is within the warranty period.

Parts and Labor

There will be no charge for parts or labor during the warranty period. Replacement parts and Products may be new or recertified at VIZIO's option and sole discretion. Replacement parts and Products are warranted for the remaining portion of the original warranty or for ninety (90) days from warranty service or replacement, whichever is greater.

Type of Service

Defective Products must be sent to a VIZIO service center to obtain warranty service. VIZIO is not responsible for transportation costs to the service center, but VIZIO will cover return shipping to the customer. PRE-AUTHORIZATION IS REQUIRED BEFORE SENDING ANY PRODUCT TO A VIZIO SERVICE CENTER FOR WARRANTY SERVICE.

Product returns to VIZIO's service centers must utilize either the original carton box and shipping material or packaging that affords an equal degree of protection. VIZIO Technical Support will provide instructions for packing and shipping the covered Product to the VIZIO service center.

Limitations and Exclusions

VIZIO's one-year limited warranty only covers defects in materials and workmanship. This warranty does not cover, for example: cosmetic damage, normal wear and tear, improper operation, improper voltage supply or power surges, signal issues, damages from shipping, acts of God, any type of customer misuse, modifications or adjustments, as well as installation and set-up issues or any repairs attempted by anyone other than by a VIZIO authorized service center. Products with unreadable or removed serial numbers, or requiring routine maintenance are not covered. This one year limited warranty does not cover Products sold "AS IS", "FACTORY RECERTIFIED", or by a non-authorized reseller.

Notice

The changes or modifications not expressly approved by the party responsible for compliance could void the user's authority to operate the equipment.

Shielded interface cables and AC power cord, if any, must be used in order to comply with the emission limits.

The manufacturer is not responsible for any radio or TV interference caused by unauthorized modification to this equipment. It is the responsibilities of the user to correct such interference.

FCC Warning

Changes or modifications not expressly approved by the party responsible for compliance with the FCC Rules could void the user's authority to operate this equipment.

Caution

Always use an AC/DC power adapter that is properly grounded. Use the AC cords listed below for each area.

USA: UL	Germany: VDE	Japan: Electric Appliance Control Act
Canada: CSA	UK: BASE/BS	

Image(s) under license from Shutterstock.com.

THERE ARE NO EXPRESS WARRANTIES OTHER THAN THOSE LISTED OR DESCRIBED ABOVE. ANY IMPLIED WARRANTIES, INCLUDING ANY IMPLIED WARRANTY OF MERCHANTABILITY AND FITNESS FOR A PARTICULAR PURPOSE, SHALL BE LIMITED IN DURATION TO THE PERIOD OF TIME SET FORTH ABOVE. VIZIO'S TOTAL LIABILITY FOR ANY AND ALL LOSSES AND DAMAGES RESULTING FROM ANY CAUSE WHATSOEVER INCLUDING VIZIO'S NEGLIGENCE, ALLEGED DAMAGE, OR DEFECTIVE GOODS, WHETHER SUCH DEFECTS ARE DISCOVERABLE OR LATENT, SHALL IN NO EVENT EXCEED THE PURCHASE PRICE OF THE PRODUCT. VIZIO SHALL NOT BE RESPONSIBLE FOR LOSS OF USE, LOSS OF INFORMATION OR DATA, COMMERCIAL LOSS, LOST REVENUE OR LOST PROFITS, OR OTHER INCIDENTAL OR CONSEQUENTIAL DAMAGES. SOME STATES DO NOT ALLOW LIMITATIONS ON HOW LONG AN IMPLIED WARRANTY LASTS OR THE EXCLUSION OF INCIDENTAL OR CONSEQUENTIAL DAMAGES, SO THE ABOVE LIMITATIONS OR EXCLUSIONS MAY NOT APPLY TO YOU. THIS WARRANTY GIVES YOU SPECIFIC LEGAL RIGHTS, AND YOU MAY ALSO HAVE OTHER RIGHTS, WHICH VARY FROM STATE TO STATE. THIS WARRANTY IS SUBJECT TO CHANGE WITHOUT NOTICE.

CHECK WWW.VIZIO.COM FOR THE MOST CURRENT VERSION.

Personal Data

If your VIZIO product is capable of storing personal data and other information, ALL CONTENTS AND INFORMATION WILL BE DELETED IN THE COURSE OF SOME IN-HOME AND ALL SHIP-IN WARRANTY SERVICE. If this occurs, your product will be restored to you configured as originally purchased. You will be responsible for restoring all applicable data and passwords. Recovery and reinstallation of user data is not covered under this Limited Warranty. In order to protect your personal information, VIZIO recommends that you always clear all personal information from the unit before it is serviced, regardless of the servicer.

Zero Bright Pixel Defect Guarantee

This policy covers "zero bright pixel" defects for the duration of the limited "ONE YEAR WARRANTY" on select new product purchases. To determine if this guarantee applies to your product, refer to the "DETAILS" tab of the model's product information page (www.VIZIO.com) or look for the "zero bright pixel" guarantee on the box.

LIMITED WARRANTY - CANADA

ONE-YEAR LIMITED WARRANTY ON PARTS AND LABOR

Covers units purchased as new in Canada

VIZIO provides a warranty to the original purchaser of a new Product against defects in materials and workmanship for a period of one year of non-commercial usage and ninety (90) days of commercial use. If a Product covered by this warranty is determined to be defective, within the warranty period, authorized for sale in Canada and from an authorized Canadian reseller, VIZIO will repair, replace or refund the unit at its sole option and discretion. VIZIO reserves the right to dispatch In-Home Service subject to availability or provide other service type options.

To obtain warranty service, contact VIZIO Technical Support via email: TechSupport@VIZIO.com or via phone at 877 MY VIZIO (877.698.4946) from 7:00AM to 11:00PM Monday through Friday and 9:00AM to 6:00PM Saturday and Sunday, Central Time, or www.vizio.ca. Pre-authorization must be obtained before sending any product to a VIZIO service center. Proof of purchase in the form of a purchase receipt or copy thereof is required to show that a Product is within the warranty period.

Parts and Labor

There will be no charge for parts or labor during the warranty period. Replacement parts and units may be new or re-certified at VIZIO's option and sole discretion. Replacement parts and units are warranted for the remaining portion of the original warranty or for ninety (90) days from warranty service or replacement, whichever is greater.

Type of Service

TV's 32" or larger will usually be serviced in-home. In-home service requires complete and easy access to the unit and does not include de-installation or re-installation of the product. In-Home Service is subject to availability. VIZIO will provide other service type options when in-home service is not available.

TV's under 32" must be sent to a VIZIO service center to obtain warranty service. VIZIO is not responsible for transportation costs to the service center, but VIZIO will cover return shipping to the customer. Pre-authorization is required before sending any unit in for warranty service.

Product returns to VIZIO's service center must utilize either the original carton/box and shipping material or packaging that affords an equal degree of protection. VIZIO Technical Support will provide instructions for packing and shipping the covered Product to the VIZIO service center.

Limitations and Exclusions

VIZIO's one-year limited warranty only covers defects in materials and workmanship. This warranty does not cover, for example, cosmetic damage, normal wear and tear, improper operation, improper voltage supply or power surges, sign issues, damages from shipping, acts of God, any type of customer misuse, modifications or adjustments, as well as installation and set-up issues or any repairs attempted by anyone other than by a VIZIO authorized service center. Products with unreadable or removed serial numbers or requiring routine maintenance are not covered. This one year limited warranty does not cover Products sold "AS IS", "CLEARANCE", "FACTORY RE-CERTIFIED", or by a non-authorized reseller.

THERE ARE NO EXPRESS WARRANTIES OTHER THAN THOSE LISTED OR DESCRIBED ABOVE. ANY IMPLIED WARRANTIES, INCLUDING ANY IMPLIED WARRANTY OF MERCHANTABILITY AND FITNESS FOR A PARTICULAR PURPOSE, SHALL BE LIMITED IN DURATION TO THE PERIOD OF TIME SET FORTH ABOVE. VIZIO'S TOTAL LIABILITY FOR ANY AND ALL LOSSES AND DAMAGES RESULTING FROM ANY CAUSE WHATSOEVER INCLUDING VIZIO'S NEGLIGENCE, ALLEGED DAMAGE, OR DEFECTIVE GOODS, WHETHER SUCH DEFECTS ARE DISCOVERABLE OR LATENT, SHALL IN NO EVENT EXCEED THE PURCHASE PRICE. IF THE PRODUCT VIZIO SHALL NOT BE RESPONSIBLE FOR LOSS OF USE, LOSS OF INFORMATION OR DATA, COMMERCIAL LOSS, LOST REVENUE OR LOST PROFITS, OR OTHER INCIDENTAL OR CONSEQUENTIAL DAMAGES. THIS WARRANTY GIVES YOU SPECIFIC LEGAL RIGHTS, AND YOU MAY ALSO HAVE OTHER RIGHTS, WHICH VARY FROM PROVINCE TO PROVINCE. THIS WARRANTY IS SUBJECT TO CHANGE WITHOUT NOTICE. CHECK www.vizio.ca FOR THE MOST CURRENT VERSION.

Personal Data

If your VIZIO product is capable of storing personal data and other information, ALL CONTENTS AND INFORMATION WILL BE DELETED IN THE COURSE OF SOME IN-HOME AND ALL SHIP-IN WARRANTY SERVICE. If this occurs, your product will be restored to you configured as originally purchased. You will be responsible for restoring all applicable data and passwords. Recovery and reinstallation of user data is not covered under this Limited Warranty. In order to protect your personal information, VIZIO recommends that you always clear all personal information from the unit before it is serviced, regardless of the service.

ZERO BRIGHT PIXEL DEFECT GUARANTEE

This policy covers "zero bright pixel" defects for the duration of the limited "ONE YEAR WARRANTY" on select new product purchases. To determine if this guarantee applies to your product, refer to the "DETAILS" tab of the model's product information page www.vizio.ca or look for the "zero bright pixel" guarantee on the box.

RE-CERTIFIED WARRANTY

NINETY DAY LIMITED WARRANTY ON PARTS AND LABOR

Covers units purchased and currently located in Canada.

IF THIS WARRANTY DOCUMENT IS RECEIVED ALONG WITH A UNIT WHICH IS PROVIDED TO THE CUSTOMER AS A WARRANTY REPLACEMENT, THE WARRANTY OF THE PURCHASED UNIT MAY SUPERSEDE THIS ONE. SUCH A REPLACEMENT UNIT IS WARRANTED FOR THE LATER OF EITHER THE REMAINING PORTION OF THE ORIGINAL WARRANTY (AS SPECIFIED BY THE ORIGINAL WARRANTY DOCUMENTATION AND DERIVED FROM THE ORIGINAL PURCHASE DATE) OR THE WARRANTY PERIOD SPECIFIED HEREIN (AS DERIVED FROM THE DATE THE REPLACEMENT UNIT IS RECEIVED).

VIZIO provides a warranty to the original purchaser of its products against defects in materials and workmanship for a period of ninety (90) days of non-commercial use. If a Product covered by this warranty is determined to be defective, within the warranty period, authorized for sale in Canada and from an authorized Canadian reseller, VIZIO will repair, replace or refund the unit at its sole option and discretion. VIZIO reserves the right to dispatch In-Home Service subject to availability or provide other service type options.

To obtain warranty service, contact VIZIO Technical Support via email: TechSupport@VIZIO.com or via phone at 877 MY VIZIO (877.698.4946) from 7:00AM to 11:00PM Monday through Friday and 9:00AM to 6:00PM Saturday and Sunday, Central Time, or visit www.vizio.ca. Proof of purchase in the form of a purchase receipt or copy thereof is required.

Parts and Labor

There will be no charge for parts or labor during the warranty period. Replacement parts and units may be new or re-certified at VIZIO's option and sole discretion. Replacement parts and units are warranted for the remaining portion of the original warranty or for ninety (90) days from warranty service or replacement, whichever is later.

Types of Service

Units 32" or larger will usually be serviced in-home. In-home service requires complete and easy access to the unit and does not include de-installation or re-installation of the product. However, in some cases, it may be necessary to send the unit to a VIZIO service center. VIZIO will cover the transportation charges to and from the same customer location.

Units less than 32" must be sent to a VIZIO service center. VIZIO is not responsible for transportation costs to the service center, but VIZIO will cover return shipping to the customer. Pre-authorization is required before sending any unit in for service.

Any returns to VIZIO's service centers must utilize either the original carton box and shipping material or a replacement box and material provided by VIZIO. VIZIO technical support will provide instructions for packing and shipping the unit to the VIZIO service center.

Limitations and Exclusions

VIZIO's ninety-day limited warranty only covers defects in materials and workmanship. Items not covered include but are not limited to cosmetic damage, normal wear and tear, misuse, signal issues, power surges, and damages from shipping, acts of God, any sort of customer misuse, installation, customer modifications, adjustments, and set-up issues. Units with unreadable or removed serial numbers, "image burn-in", and routine maintenance are not covered. This warranty does not cover products sold "AS IS", "CLEARANCE" or by a non-authorized reseller.

THERE ARE NO EXPRESS WARRANTIES OTHER THAN THOSE LISTED OR DESCRIBED ABOVE. ANY IMPLIED WARRANTIES, INCLUDING ANY IMPLIED WARRANTY OF MERCHANTABILITY AND FITNESS FOR A PARTICULAR PURPOSE, SHALL BE LIMITED IN DURATION TO THE PERIOD OF TIME SET FORTH ABOVE. VIZIO'S TOTAL LIABILITY FOR ANY AND ALL LOSSES AND DAMAGES RESULTING FROM ANY CAUSE WHATSOEVER SHALL IN NO EVENT EXCEED THE PURCHASE PRICE OF THE DISPLAY. VIZIO SHALL NOT BE RESPONSIBLE FOR LOSS OF USE, COMMERCIAL LOSS, LOST REVENUE OR LOST PROFITS, OR OTHER INCIDENTAL OR CONSEQUENTIAL DAMAGES. SOME STATES DO NOT ALLOW LIMITATIONS ON HOW LONG AN IMPLIED WARRANTY LASTS OR THE EXCLUSION OF INCIDENTAL OR CONSEQUENTIAL DAMAGES, SO THE ABOVE LIMITATIONS OR EXCLUSIONS MAY NOT APPLY TO YOU. THIS WARRANTY GIVES YOU SPECIFIC LEGAL RIGHTS, AND YOU MAY ALSO HAVE OTHER RIGHTS, WHICH VARY FROM PROVINCE TO PROVINCE. THIS WARRANTY IS SUBJECT TO CHANGE WITHOUT NOTICE. CHECK www.vizio.ca FOR THE MOST CURRENT VERSION.

Service and Parts Information

ELECTRONIC SPARE PARTS

VIZIO offers these supplier parts contact information for your convenience. In the event service is needed on your VIZIO product (after the warranty period) and a replacement part is required, please contact one of the following VIZIO authorized spare parts distributors with the required part number.

Vizparts.com Inc

710 Epperson Drive, Suite B

City of Industry, CA 91748

(888) 260-7765

www.vizparts.com

LIMITED WARRANTY - MEXICO

ONE-YEAR LIMITED WARRANTY ON PARTS AND LABOR

Covers units purchased as new in Mexico Only.

VIZIO Sales & Marketing México S. de. R.L. de C.V. provides a warranty to the original purchaser of a new Product against defects in materials and workmanship for a period of one year of non-commercial usage or ninety (90) days of commercial use. If a Product covered by this warranty is determined to be defective within the warranty period, VIZIO Sales & Marketing México S. de. R.L. de C.V. will either repair or replace the unit at its sole option and discretion.

To obtain warranty service, contact VIZIO Sales & Marketing México S. de. R.L. de C.V. Technical Support via email: apoyotecnico.mx@VIZIO.com or via phone at 001 (855) 472-7444 from 9:00AM to 6:00PM Monday through Friday, Central Time, or visit www.VIZIO.mx. Pre-authorization must be obtained before sending any product to a VIZIO Sales & Marketing México S. de. R.L. de C.V. service Center. Proof of purchase in the form of a purchase receipt or copy thereof is required to show that a Product is within the warranty period.

Parts and Labor

There will be no charge for parts or labor during the warranty period. Replacement parts and units may be new or recertified at VIZIO Sales & Marketing México S. de. R.L. de C.V.'s option and sole discretion. Replacement parts and units are warranted for the remaining portion of the original warranty or for ninety (90) days from warranty service or replacement, whichever is greater.

Type of Service

Product returns to VIZIO Sales & Marketing México S. de. R.L. de C.V.'s service centers must utilize either the original carton box and shipping material or packaging that affords an equal degree of protection. VIZIO Sales & Marketing México S. de. R.L. de C.V. Technical Support will provide instructions for packing and shipping the covered Product to the VIZIO Sales & Marketing México S. de. R.L. de C.V. service center.

Limitations and Exclusions

VIZIO Sales & Marketing México S. de. R.L. de C.V.'s one-year limited warranty only covers defects in materials and workmanship. This warranty does not cover, for example: cosmetic damage, normal wear and tear, improper operation, improper voltage supply or power surges, signal issues, damages from shipping, acts of God, any type of customer misuse, modifications or adjustments, as well as installation and set-up issues or any repairs attempted by anyone other than by a VIZIO Sales & Marketing México S. de. R.L. de C.V. authorized service center. Products with unreadable or removed serial numbers, or requiring routine maintenance are not covered. This one year limited warranty does not cover Products sold "AS IS", "FACTORY RECERTIFIED", or by a non-authorized reseller.

THESE ARE NO EXPRESS WARRANTIES OTHER THAN THOSE LISTED OR DESCRIBED ABOVE. ANY IMPLIED WARRANTIES, INCLUDING ANY IMPLIED WARRANTY OF MERCHANTABILITY AND FITNESS FOR A PARTICULAR PURPOSE, SHALL BE LIMITED IN DURATION TO THE PERIOD OF TIME SET FORTH ABOVE. VIZIO Sales & Marketing México S. de. R.L. de C.V.'S TOTAL LIABILITY FOR ANY AND ALL LOSSES AND DAMAGES RESULTING FROM ANY CAUSE WHATSOEVER INCLUDING VIZIO Sales & Marketing México S. de. R.L. de C.V.'S NEGLIGENCE, ALLEGED DAMAGE, OR DEFECTIVE GOODS, WHETHER SUCH DEFECTS ARE DISCOVERABLE OR LATENT, SHALL IN NO EVENT EXCEED THE PURCHASE PRICE OF THE PRODUCT. VIZIO Sales & Marketing México S. de. R.L. de C.V. SHALL NOT BE RESPONSIBLE FOR LOSS OF USE, LOSS OF INFORMATION OR DATA, COMMERCIAL LOSS, LOST REVENUE OR LOST PROFITS, OR OTHER INCIDENTAL OR CONSEQUENTIAL DAMAGES. Some states do not allow limitations on how long an implied warranty lasts or the exclusion of incidental or consequential damages, so the above limitations or exclusions may not apply to you. This warranty gives you specific legal rights, and you may also have other rights, which vary from state to state. THIS WARRANTY IS SUBJECT TO CHANGE WITHOUT NOTICE. CHECK www.VIZIO.mx FOR THE MOST CURRENT VERSION.

Personal Data

If your VIZIO Sales & Marketing México S. de. R.L. de C.V. product is capable of storing personal data and other information, ALL CONTENTS AND INFORMATION WILL BE DELETED IN THE COURSE OF SOME IN-HOME AND ALL SHIP-IN WARRANTY SERVICE. If this occurs, your product will be restored to you configured as originally purchased. You will be responsible for restoring all applicable data and passwords. Recovery and reinstallation of user data is not covered under this Limited Warranty. In order to protect your personal information, VIZIO Sales & Marketing México S. de. R.L. de C.V. recommends that you always clear all personal information from the unit before it is serviced, regardless of the servicer.

ZERO BRIGHT PIXEL DEFECT GUARANTEE

This policy covers "zero bright pixel" defects for the duration of the limited "ONE YEAR WARRANTY" on select new product purchases. To determine if this guarantee applies to your product, refer to the "DETAILS" tab of the model's product information page www.VIZIO.mx or look for the "zero bright pixel" guarantee on the box.

INFORMATION EXCLUSIVELY FOR MEXICO

VIZIO Sales & Marketing México S. de. R.L. de C.V. is not obligated to honor the warranty in the following cases.

- When the Product has been used under other than normal conditions.
- When the Product has not been operated according to the accompanying instructions for use.
- When the Product has been altered or repaired by persons not authorized by VIZIO Sales & Marketing México S. de. R.L. de C.V. or the respective seller.

You may contact the importer or the merchant from whom you purchased the VIZIO Sales & Marketing México S. de. R.L. de C.V. Product to make a warranty claim, to obtain information related to the procedure to file a warranty claim, and to obtain information related to parts, components, supplies and accessories, or contact VIZIO Sales & Marketing México S. de. R.L. de C.V.'s authorized representative as follows:

Integral Support S. A. de C. V.

Calle Juan Augusto Ingres. 140

Col. Santa María Nonoalco

Del. Benito Juárez

México, D. F. C.P 03700

Customer Service: 001 (855) 472-7444

To make a warranty claim, submit this Product and this policy, duly stamped by the establishment from which it was purchased. For customers in Mexico with VIZIO Sales & Marketing México S. de. R.L. de C.V. televisions that are larger than 32 inches, VIZIO Sales & Marketing México S. de. R.L. de C.V. or its authorized representative will provide onsite warranty coverage of repair and/or replacement services.

Under the terms of this warranty, VIZIO Sales & Marketing México S. de. R.L. de C.V. or its representative must exchange parts and components of the Product and include labor and shipping expenses of the Product on which this warranty is valid, within the service network, at no cost to the consumer.

VIZIO Sales & Marketing México S. de. R.L. de C.V.

Conquistadores 105 Interior 7,

Colonia Mirasiera, San Pedro Garza Garcia,

Nuevo Leon, C.P. 66240, Mexico.

RFC: VSA110513BK9

Telephone: 001 (855) 472-7444

